

Instructions for Use for Orthotists or Qualified/Trained Experts System Knee Joint



NEURO LOCK H₂O

Download: www.fior-gentz.com

Content	Page
1. Information	4
2. Safety Instructions	4
2.1 Classification of the Safety Instructions	4
2.2 All Instructions for a Safe Handling of the System Knee Joint	4
3. Use	7
3.1 Intended Use	7
3.2 Indication	7
3.3 Contraindication	7
3.4 Qualification	7
3.5 Application	7
3.6 Combination Possibilities with Other System Joints	7
4. Joint Function	8
5. Scope of Delivery	9
6. Load Capacity	9
7. Tools for Assembling the System Joint	9
8. Assembly Instructions	10
8.1 Mounting the Locking Pawl	10
8.2 Mounting the Extension Stop	10
8.3 Mounting the Joint's Lower Part	11
8.4 Checking the System Joint's Free Movement	11
8.5 Checking the Lock Function	11
8.6 Securing the Screws	12
9. Mounting the Lever Extension	12
10. Notes on the Production of the Orthosis	13
10.1 Mounting to the System Anchor	13
11. Conversion of the NEURO LOCK H ₂ O System Knee Joint	13
12. Advice on Optimal Orthosis Functionality	14
13. Maintenance	14
13.1 Documentation of Maintenance in the Orthosis Service Passport	15
13.2 Replacing the Sliding Washers	15
13.3 Dirt Removal	15
14. Period of Use	16
15. Storage	16

.....



16. Spare Parts	17
16.1 Exploded View Drawing NEURO LOCK H ₂ O	17
16.2 Spare Parts for the NEURO LOCK H ₂ O System Knee Joint	18
16.3 Sliding Washers	18
17. Disposal	19
18. Signs and Symbols	19
19. CE Conformity	20
20. Legal Information	20
21. Information for the Treatment Documentation	21
22. Handing Over the Orthosis	22

1. Information

These instructions for use are addressed to orthotists or qualified/trained experts and do not contain any notes about dangers which are obvious to them. To achieve maximum safety, please instruct the patient and/or care team in the use and maintenance of the product.

2. Safety Instructions

2.1 Classification of the Safety Instructions

 DANGER	Important information about a possible dangerous situation which, if not avoided, leads to death or irreversible injuries.
 WARNING	Important information about a possible dangerous situation which, if not avoided, leads to reversible injuries that need medical treatment.
 CAUTION	Important information about a possible dangerous situation which, if not avoided, leads to light injuries that do not need medical treatment.
<i>NOTICE</i>	Important information about a possible situation which, if not avoided, leads to damage of the product.

All serious incidents according to Regulation (EU) 2017/745 which are related to the product have to be reported to the manufacturer and to the competent authority of the member state in which the orthotist or qualified/trained expert and/or the patient is established.

2.2 All Instructions for a Safe Handling of the System Knee Joint

DANGER

Potential Traffic Accident Due to Limited Driving Ability

Advise the patient to gather information about all safety and security issues before driving a motor vehicle with orthosis. The patient should be able to drive a motor vehicle safely.

WARNING

Jeopardising the Therapy Goal by Not Providing the Necessary Free Movement

Check if the system joint moves freely in order to avoid restrictions of the joint function. Use suitable sliding washers according to the information in these instructions for use.

WARNING

Risk of Falling Due to Permanent Higher Load

If patient data has changed (e.g. due to weight gain, growth or increased activity), recalculate the expected load on the system joint, plan the treatment again and, if necessary, produce a new orthosis.

WARNING

Risk of Falling Due to Improper Processing

Process the system joint according to the information in these instructions for use. Deviating processing and modifications of the system joint require the written consent of the manufacturer.

WARNING

Risk of Falling Due to Improper Handling

Inform the patient about the correct use of the system joint and potential dangers especially with regards to:

- excessive mechanical stress (e.g. due to sports, increased activity or weight gain) and
- unintentional unlocking of the system joint under flexion load.

WARNING

Risk of Falling Due to Loosened Bearing Nuts

Secure the screws of the bearing nuts with the specified torque and the corresponding adhesive and make sure that no sliding washers are damaged in the process.

WARNING

Risk of Falling Due to Incorrectly Selected System Components

Make sure that the system joint and the system components are not overloaded and are functionally adapted to the requirements and needs of the patient in order to avoid joint dysfunction.

WARNING

Risk of Falling Due to Improper Shoe/Wrong Shoe Pitch

Advise the patient to wear a shoe to which the orthosis is adjusted in order to avoid joint dysfunction.

WARNING

Risk of Falling Due to Greased Locking Parts

Grease the system joint only slightly. Make sure that no grease enters between locking pawl and joint's lower part.

WARNING

Risk of Falling Due to Play in the System Joint

In order to achieve a lock function that is free of play, mount the system joint as described in these instructions for use. Check in particular if the system joint locks without play. Correct play by using the precisely adjustable extension stop or exchange the locking pawl, if necessary.

WARNING

Risk of Falling Due to Insufficient Rigidity of the Orthosis

Ensure sufficient rigidity of the orthosis shells during the construction of the orthosis in order to prevent it from bending or distorting over time and thus impairing the lock function.

WARNING

Damage to the Anatomical Joint Due to Incorrect Position of the Joint's Mechanical Pivot Point

Determine the joint's mechanical pivot points correctly in order to avoid a permanent incorrect load on the anatomical joint. Please refer to the online tutorials on our website or contact Technical Support.

NOTICE

Limitation of the Joint Function Due to Improper Processing

Errors in processing can impair the joint function. Pay particular attention to:

- correctly connect the system anchor with the system joint in accordance with the production technique;
- grease the joint components only *slightly* and
- adhere to the maintenance intervals.

NOTICE

Failure of the Lock Function Due to Incorrectly Mounted Lever Extension

Adhere the lever extension to the locking pawl as described in these instructions for use.

NOTICE

Limitation of the Joint Function Due to Improper Dirt Removal

Inform the patient on how to properly remove dirt from the orthosis and the system joint.

NOTICE

Limitation of the Joint Function Due to Lack of Maintenance

Respect the specified maintenance intervals in order to avoid joint dysfunction. Inform the patient about the maintenance appointments to be respected. Enter the next maintenance appointment in the orthosis service passport of the patient.

3. Use

3.1 Intended Use

The **NEURO LOCK H₂O** system knee joint is exclusively for use for orthotic fittings of the lower extremity. The system joint is only allowed to be used for producing a KAFO. Every system joint influences the orthosis' function and thus also the function of the leg. The system joint may only be used for one fitting and must not be reused.

3.2 Indication

The indications for the treatment with an orthosis for the lower extremity are insecurities that lead to a pathological gait. These can be caused, for example, by central, peripheral, spinal or neuromuscular paralyses, structurally conditioned deformities/malfunctions or surgery.

The physical conditions of the patient, such as muscle strength or activity level, are crucial for the orthotic treatment. An evaluation regarding the safe handling of the orthosis by the patient must be carried out.

3.3 Contraindication

The system joint is not suitable for treatments that were not described in paragraph 3.2, such as a treatment of the upper extremity or a treatment with a prosthesis or ortho-prosthesis, for example after amputations of leg segments.

3.4 Qualification

The system joint must only be handled by an orthotist or a qualified/trained expert.

3.5 Application

All **FIOR & GENTZ** system joints were developed for everyday life activities such as standing and walking. Extreme loads connected to activities like running, climbing and parachuting are excluded. The **NEURO LOCK H₂O** system knee joint is water-resistant and, therefore, it is suitable for use in wet areas. It is equipped with a water-resistant carbon fibre reinforced joint case and a seawater-resistant stainless steel screwing. The system joint can be used at a maximum temperature of +60°C.

3.6 Combination Possibilities with Other System Joints

The **NEURO LOCK H₂O** system knee joint can be mounted in combination with water-resistant system ankle joints from our product range in a water-resistant orthosis. The **NEURO CLASSIC H₂O** system knee joint can be used as supporting joint.

We recommend that you use the Orthosis Configurator when selecting all system components for your orthosis and follow the recommendations of the configuration result.

4. Joint Function

The NEURO LOCK H₂O is a locked system knee joint. It is preassembled in a physiological joint angle of 5°. Due to the used system components, it has the additional functions listed below:

System Component	Function
fixing pawl	permanent unlocking of the system knee joint

System Component	Function
extension stop	limitation of the maximum extension in 5°; correction of play in the system joint in ap direction

Fixing Pawl

The system joint can be used as free moving joint with an integrated posterior offset by means of the permanent unlock function (fig. 1).

System Width	14mm	16mm	20mm
Posterior Offset of the Joint Axis	14mm	16mm	20mm

The lock function can be disabled permanently by means of the fixing pawl.

- 1 Press the locking pawl against the joint's upper part.
- 2 Hold the locking pawl in this position.
- 3 In order to obtain a free moving system joint, press the fixing pawl against the joint's upper part until it snaps into the joint's upper part.

In order to disable the permanent unlock function, the locking pawl must be pressed against the joint's upper part again. The unloaded fixing pawl is released from the joint's upper part. As soon as the system joint is in maximum extension, the locking pawl locks in its normal position.



Fig. 1

5. Scope of Delivery

Description	Quantity
system knee joint (fig. 2)	1
assembly/lamination dummy (fig. 3)	1
orthosis joint grease, 3g (without figure)	1
set 2-component adhesive with primer (fig. 4)	1
lever extension (without figure)	1
connecting tube for lever extension (without figure)	1



Fig. 2



Fig. 3

6. Load Capacity

The load capacity results from the relevant patient data and can be determined by using the Orthosis Configurator. We recommend that you use the system components determined by the Orthosis Configurator when producing an orthosis and mind the recommended production technique.



Fig. 4

7. Tools for Assembling the System Joint

Tools	System Width		
	14mm	16mm	20mm
T8 hexalobular screwdriver/bit	x	x	x
T10 hexalobular screwdriver/bit	x	-	-
T15 hexalobular screwdriver/bit	x	x	x
T20 hexalobular screwdriver/bit	-	x	x
torque screwdriver 1-6Nm	x	x	x
sliding washer centring pin	x	x	x

8. Assembly Instructions

The system joint is delivered fully assembled. All functions are checked beforehand. You have to disassemble the system joint for mounting it in the orthosis and for maintenance. To ensure an optimal functioning, follow the assembly instructions below. Secure all screws with the torque specified in paragraph 8.6.



Only use the FIOR & GENTZ orthosis joint grease to grease the system components.

8.1 Mounting the Locking Pawl

- 1 Before the assembly, clean the threads of the bearing nuts with LOCTITE® 7063 Super Clean. Allow the threads to air-dry for 10 minutes.
- 2 Stick the pressure spring into the spring guide.
- 3 Insert the spring guide including the pressure spring from below into the spring duct of the joint's upper part (fig. 5).
- 4 Grease the axle bore of the locking pawl and the sliding surfaces of the locking pawl's bearing nut with a drop of orthosis joint grease.
- 5 Mount the locking pawl with premounted fixing pawl into the joint's upper part (fig. 6)
- 6 Put the bearing nut for the locking pawl into the intended opening of the joint's upper part. Make sure that the cut-outs of the bearing nut and the joint's upper part match (fig. 7). The bearing nut must be fully inserted in the opening.
- 7 Place the cover disc of the locking pawl onto the front of the joint's upper part. Make sure that the cut-outs of the cover disc and the joint's upper part match.
- 8 Fix the locking pawl by pushing it upwards and letting the fixing pawl snap into place on the joint's upper part.
- 9 Screw in the countersunk flat head screw (S1; fig. 8).



Fig. 5



Fig. 6



Fig. 7



Fig. 8

8.2 Mounting the Extension Stop

- 1 Stick the cheese head screw (1; fig. 9) into the extension stop (2).
- 2 Place the pressure spring (3) onto the cheese head screw (1).
- 3 Screw the sub-assembly into the joint's lower part.



The extension stop influences the position of the locking pawl. The further the extension stop is screwed in, the higher the position of the locking pawl is. Note paragraph 8.5 for the ideal position of the locking pawl.



Fig. 9

8.3 Mounting the Joint's Lower Part

- 1 Grease the two sliding washers **slightly** on both sides with orthosis joint grease.
- 2 Place the sliding washers on both sides of the joint's lower part. Do not place the sliding washers centrally, but slightly above the bore (fig. 10).
- 3 Slide the joint's lower part from below into the joint's upper part (fig. 11). Make sure that the sliding washers are centred correctly (fig. 12). To do so, use the sliding washer centring pin.
- 4 Grease the axle bore of the joint axis and the sliding surfaces of the bearing nut of the joint axis **with a drop** of orthosis joint grease.
- 5 Put the bearing nut of the joint axis into the opening of the joint's upper part. Make sure that the cut-outs of the bearing nut and the joint's upper part match (fig. 13). The bearing nut must be fully inserted in the opening.
- 6 Place the cover disc of the joint axis onto the front of the joint's upper part. The cover disc must be fully inserted in the opening. Make sure that the cut-outs of the cover disc and the joint's upper part match.
- 7 Screw in the countersunk flat head screw (axle screw, S2; fig. 14).



Fig. 10



Fig. 11



Fig. 12



Fig. 13

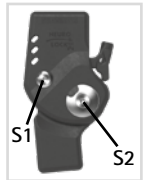

Fig. 14

8.4 Checking the System Joint's Free Movement

Secure the screws for the joint's upper part with the appropriate torque (see paragraph 8.6). Check if the system joint moves freely. If the system joint runs with lateral play, mount the next thicker sliding washer. If it does not move freely (it is jammed), mount the next thinner sliding washer.

8.5 Checking the Lock Function

- 1 Unlock the system joint again and have the locking pawl snap in maximum extension. You should hear a distinct "click" when the system joint locks.
- 2 Check the correct position of the locking pawl. It must not be mounted too high (fig. 15).



Fig. 15

The locking pawl should be free of play in the lowest position. If you note play in the system joint in ap direction, you can correct it by using the precisely adjustable extension stop. To do so, screw in the cheese head screw of the extension stop until the locking pawl falls into the joint's lower part as shown (fig. 16) and there is no play remaining.



Fig. 16

8.6 Securing the Screws

The screws are secured after the orthosis has been produced and tried on and before it is handed over to the patient.

- 1 Loosen the screws for the joint's upper part (fig. 14) after checking the system joint's free movement and remove them from the joint's upper part.
- 2 Apply a small drop of LOCTITE® 243 medium strength to the threads of the screws.
- 3 Secure the screws for the joint's upper part (fig. 14) with the torque corresponding to the system width.
- 4 Let the adhesive harden (final strength after approx. 24 hours).

Screws for Joint's Upper Part	System Width		
	14mm	16mm	20mm
S1 (screw 1)	1.5Nm	3Nm	3Nm
S2 (screw 2, axle screw)	3Nm	4Nm	4Nm



The screws for the joint's upper part are not secured with the necessary torque at delivery. You can also find information on the torque on the cover discs of the system joint.

9. Mounting the Lever Extension

The lever extension is used for an easy unlocking of the system knee joint. The adhesive set (fig. 3) for adhering the lever extension consists of a 2-component adhesive and a primer. It is included in the scope of delivery of the system joint and can be reordered separately.

Unilateral Construction

- 1 Adapt the lever extension to the shape of the orthosis and shorten it, if necessary.
- 2 Apply a thin layer of primer on the shoulder of the lever extension and in the bore of the locking pawl by using the cotton swab from the adhesive set (fig. 17).
- 3 Allow the primer to flash off for 10 minutes.
- 4 Inject a sufficient amount of the 2-component adhesive into the bore of the locking pawl by using the set's dual-chamber syringe.
- 5 Stick the lever extension into the bore (fig. 18).
- 6 Let the adhesive dry for 24 hours until the final strength is reached.

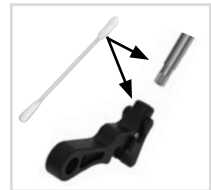

Fig. 17



Fig. 18

Bilateral Construction

- 1 Adapt the lever extensions to the shape of the orthosis.
- 2 Connect the lever extensions at a distance of approx. 1mm by means of the connecting tube for lever extension (fig. 19).
- 3 Apply a thin layer of primer on the shoulder of the lever extensions and in the bore of the locking pawls by using the cotton swab from the adhesive set (fig. 17).
- 4 Allow the primer to flash off for 10 minutes.
- 5 Inject a sufficient amount of the 2-component adhesive into the bore of the locking pawls by using the set's dual-chamber syringe.
- 6 Stick the lever extensions into the bores (fig. 18).
- 7 Let the adhesive dry for 24 hours until the final strength is reached.

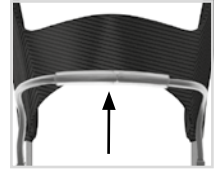

Fig. 19



The 2-component adhesive is a disposable product. Adhere the lever extension and the system anchor at the same time.

10. Notes on the Production of the Orthosis

10.1 Mounting to the System Anchor

The system anchor of the **NEURO LOCK H₂O** system knee joint must be adhered to the system joint in accordance with the production technique provided in the planning (fig. 20). It is adhered after the orthosis parts have been tempered. Before using the adhesive set, make sure that the expiry date has not yet passed. The adhesive set should be stored in a cool place.



Fig. 20



Note that the orthosis must not be tempered after connecting the system anchor to the system joint. The properties of the adhesive connection change at temperatures that are too high.

You will find more detailed information in the **Instructions for Use for Orthotists or Qualified/Trained Experts System Anchors for Water-Resistant System Joints**. You will find information on the production techniques in the section "Online Tutorials" on our website www.fior-gentz.com.

11. Conversion of the NEURO LOCK H₂O System Knee Joint

The **NEURO LOCK H₂O** system knee joint can be functionally converted into the **NEURO CLASSIC H₂O** system knee joint. To do this, remove the locking pawl, spring guide and pressure spring (fig. 21).



Fig. 21

12. Advice on Optimal Orthosis Functionality

Problem	Cause	Measure
The system joints do not unlock.	The locking and unlocking parts are still loaded.	The patient has to take the body weight off of the orthosis (e.g. by sitting down on a chair).
	The patient does not apply an extension moment.	The patient has to take the body weight off of the orthosis (e.g. by sitting down on a chair) and has to apply an extension moment themselves or with the assistance of another person (e.g. by pushing the knee backwards).
The system joints do not lock correctly.	The orthosis is not torsion-resistant (bilateral construction). Only one system joint locks.	The system joints must be locked with passive force. The patient or another person must push the knee backwards.
	One system joint is/both system joints are still in permanent unlock function.	The locking pawl must be pressed against the joint's upper part until the fixing pawl is released from the joint's upper part. The patient must fully extend their knee until the system joint locks.

13. Maintenance

Check the system joint regularly for wear and functionality. In particular, check the joint components listed in the following table for the possible problems described and, if necessary, take the appropriate measures. Also check the functionality after every maintenance carried out. It must be possible to move the system joint without problems or unusual noises. Make sure that there is no lateral play.

Joint Component	Potential Problem	Measure	Inspection/Replacement, If Necessary	Latest Replacement
sliding washer	wear	replacing sliding washer, see paragraph 13.2	every 6 months	every 18 months
sliding bushing	wear	replacing sliding bushing	every 6 months	every 18 months
pressure spring	wear	replacing pressure spring	every 6 months	every 18 months
countersunk flat head screw	wear	replacing countersunk flat head screw	every 6 months	every 36 months
locking pawl	wear	replacing locking pawl	every 6 months	every 36 months
bearing nut	wear	replacing bearing nut	every 6 months	every 36 months
extension stop	wear	replacing extension stop	every 6 months	not applicable
spring guide	wear	replacing spring guide	every 6 months	not applicable
pulling cable	wear	replacing pulling cable	every 6 months	not applicable

Clean the threads of the bearing nuts with LOCTITE® 7063 Super Clean at every maintenance. Allow the threads to air-dry for 10 minutes.

Secure the screws for the joint's upper part with the torque corresponding to the system width and LOCTITE® 243 medium strength at every maintenance (see paragraph 8.6). Remove all adhesive residues first.

13.1 Documentation of Maintenance in the Orthosis Service Passport

The patient receives an orthosis service passport from their orthotist or a qualified/trained expert, when the orthosis is handed over. The orthosis must be checked every 6 months in order to maintain its function and to ensure the safety of the patient. The maintenance appointments are noted and confirmed in the orthosis service passport.



Fig. 22

13.2 Replacing the Sliding Washers

Sliding washers are available in different thicknesses (e.g. GS2413-040 is 0.40mm thick). Each thickness has a different marking (fig. 23). You will find the article numbers of the premounted sliding washers on the back page of these instructions for use.

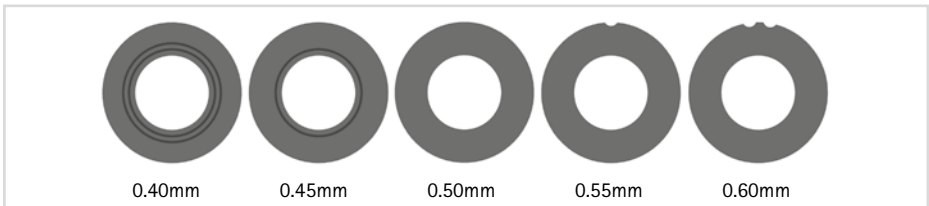

Fig. 23

13.3 Dirt Removal

The **NEURO LOCK H₂O** system knee joint is suited for a usage in wet areas. Nevertheless, dirt must be removed when necessary and during regular maintenance. For this purpose, disassemble the system joint and clean the soiled system components with a dry cloth.

In order to optimise the lifespan, we recommend rinsing the orthosis with clear tap water, especially after using it in salt water, chlorine water and sand.

14. Period of Use

To guarantee a safe use and complete functionality as well as an unlimited period of use of the system joints, you must adhere to the following conditions:

- 1 Adhere to the specified maintenance intervals without interruption and document each maintenance (see paragraph 13).
- 2 Adhere to the determined maintenance conditions (see paragraph 13).
- 3 Check the wear parts, as required, and exchange them in the defined intervals (see paragraph 13).
- 4 Check the adjustment of the system joint during maintenance and correct it, if necessary (see paragraph 13).
- 5 Check the functionality of the system joint during maintenance (see paragraph 13).
- 6 The maximum load determined during the planning of the custom-made product shall not be exceeded by changes in the patient data (e.g. due to weight gain, growth or increased activity). If the determined maximum load on the system joints is exceeded, the system joint must no longer be used. When planning the custom-made product, expected changes in patient data need to be taken into account.
- 7 The period of use of the water-resistant system joints can be affected by use in salt water, chlorine water or sand. After use in salt water, chlorine water or sand, rinse the system joint with clear tap water. Instruct the patient accordingly.
- 8 The period of use of the system joints ends with the period of use of the custom-made product (orthosis).
- 9 The multiple use of the system joint in another custom-made product is not allowed (see paragraph 20).

15. Storage

It is recommended to store the system joint in its original packaging until the custom-made product is produced.

16. Spare Parts

16.1 Exploded View Drawing NEURO LOCK H₂O

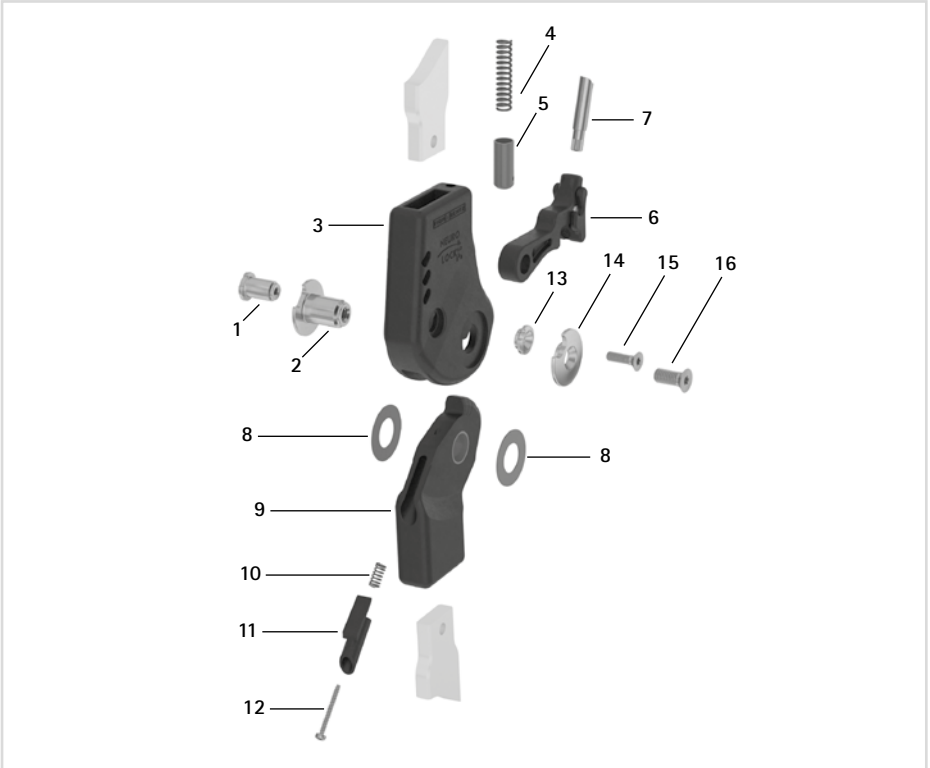

Fig. 24

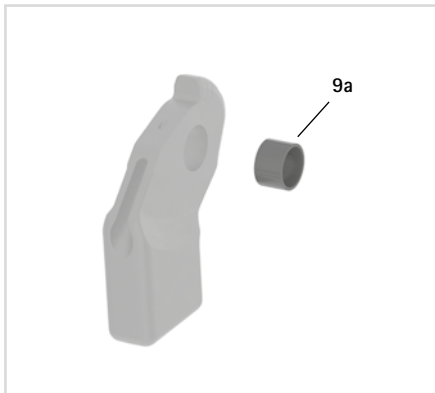

Fig. 25

16.2 Spare Parts for the NEURO LOCK H₂O System Knee Joint

Item	Article Number for System Width			Description
	14mm	16mm	20mm	
1	SK0892-3/C	SK0893-3/C	SK0895-3/C	bearing nut (locking pawl)
2	SK0892-1/C	SK0893-1/C	SK0895-1/C	bearing nut (joint axis)
3	SK0802-C	SK0803-C	SK0805-C	upper part, straight, carbon
4	FE1530-01	FE1530-01	FE1733-02	pressure spring
5	SK0872-10/C	SK0872-10/C	SK0875-10/C	spring guide
6	SK0872-5/C	SK0873-5/C	SK0875-5/C	5° locking pawl with fixing pawl, carbon-titanium hybrid
7	SK0872-51/C	SK0875-51/C	SK0875-51/C	lever extension
8	GS2009-*	GS2311-*	GS2413-*	sliding washer*
9	SK0812-2/C	SK0813-2/C	SK0815-2/C	5° lower part with sliding bushing, straight, carbon-titanium hybrid
9a	BP1009-L059	BP1211-L077	BP1412-L090	sliding bushing
10	FE1510-02	FE1510-02	FE1510-02	pressure spring
11	SK9802-E005/C	SK9803-E005/C	SK9805-E005/C	5° extension stop
12	SC4402-L22	SC4402-L22	SC4402-L22	cheese head screw
13	SK0892-4/C	SK0895-4/C	SK0895-4/C	cover disc (locking pawl)
14	SK0892-2/C	SK0893-2/C	SK0895-2/C	cover disc (joint axis)
15	SC1403-L08	SC1404-L12	SC1404-L14	countersunk flat head screw with hexalobular socket
16	SC1404-L10	SC1405-L14	SC1406-L14	countersunk flat head screw with hexalobular socket (axle screw)

16.3 Sliding Washers

* Sliding Washers			
	Article Number for System Width		
	14mm	16mm	20mm
	Ø = 20mm	Ø = 23mm	Ø = 24mm
	GS2009-040	GS2311-040	GS2413-040
	GS2009-045	GS2311-045	GS2413-045
	GS2009-050	GS2311-050	GS2413-050
	GS2009-055	GS2311-055	GS2413-055
	GS2009-060	GS2311-060	GS2413-060

17. Disposal

Dispose of the system joint and its individual parts properly. The product must not be disposed of with the residual waste (fig. 26). Please comply with the applicable national laws and local regulations for the proper recycling of recyclable materials.



Fig. 26



For proper disposal, it is necessary to demount the system joint from the orthosis.

18. Signs and Symbols

Symbols on the Packaging



CE labelling according to Regulation (EU) 2017/745 for medical devices



medical device



article number



manufacturer



batch code



follow the instructions for use



single patient – multiple uses



Unique Device Identifier – product identification number

19. CE Conformity

We declare that our medical devices as well as our accessories for medical devices are in conformity with the requirements of Regulation (EU) 2017/745. Therefore, the FIOR & GENTZ products bear the CE marking.

20. Legal Information

With the purchase of this product, our General Terms and Conditions of Business Transactions, Sales, Delivery and Payment will apply. The warranty expires, for example, if the product is mounted several times. Please note that the product is not supposed to be combined with other components or materials than with those recommended according to the configuration result from the FIOR & GENTZ Orthosis Configurator. The combination of the product with products from other manufacturers is not permitted.

The information in these instructions for use is valid at the date of printing. The contained product information serves as guidelines. Subject to technical modifications.

All rights, particularly the distribution, copy and translation of this manual or any part of it, must be authorised in writing by FIOR & GENTZ Gesellschaft für Entwicklung und Vertrieb von orthopädiotechnischen Systemen mbH. Reprints, copies and any other electronic reproduction, even partial, must be authorised in writing by FIOR & GENTZ Gesellschaft für Entwicklung und Vertrieb von orthopädiotechnischen Systemen mbH.

.....

21. Information for the Treatment Documentation

Add these instructions for use to your treatment documentation!

Patient Data

Name	
Address	
Postcode, City	
Home Telephone	
Telephone at Work	
Insurance	
Insurance No.	
Attending Physician	
Diagnosis	

22. Handing Over the Orthosis

The orthotist or qualified/trained expert has also handed over the instructions for use for patients as well as the orthosis service passport to you as a patient, parent or care team. By means of these instructions for use, the functions and handling of the orthosis were explained to you in detail. You will find the next maintenance appointment in the orthosis service passport. Bring the orthosis service passport with you to every maintenance appointment.



Place, Date

Signature Patient

Leg Side

left

right

Mounted Sliding Washer

1. GS _____ - _____

2. GS _____ - _____

